

User Manual



ES-SU1K/3K Online UPS

Uninterruptible Power Supply System

Table of Contents

1. Important Safety Warning	1
1-1. Transportation	1
1-2. Preparation	1
1-3. Installation	1
1-4. Operation	2
1-5. Maintenance, service and faults	2
2. Installation and setup	3
2-1. Rear panel view	3
2-2. Operating principle	4
2-3. UPS Installation (Only available for Rack UPS)	4
2-4. Setup the UPS	5
3. Operations	8
3-1. Button operation	8
3-2. LCD Panel	8
3-3. Audible Alarm	10
3-4. LCD display wordings index	10
3-5. UPS Setting	10
3-6. Operating Mode Description	13
3-7. Faults Reference Code	14
3-8. Warning indicator	14
4. Troubleshooting	15
5. Storage and Maintenance	16

1. Important Safety Warning

Please comply with all warnings and operating instructions in this manual strictly. Save this manual properly and read carefully the following instructions before installing the unit. Do not operate this unit before reading through all safety information and operating instructions carefully

1-1. Transportation

- Please transport the UPS system only in the original package to protect against shock and impact.

1-2. Preparation

- Condensation may occur if the UPS system is moved directly from cold to warm environment. The UPS system must be absolutely dry before being installed. Please allow at least two hours for the UPS system to acclimate the environment.
- Do not install the UPS system near water or in moist environments.
- Do not install the UPS system where it would be exposed to direct sunlight or near heater.
- Do not block ventilation holes in the UPS housing.

1-3. Installation

- Do not connect appliances or devices which would overload the UPS system (e.g. laser printers) to the UPS output sockets.
- Place cables in such a way that no one can step on or trip over them.
- Do not connect domestic appliances such as hair dryers to UPS output sockets.
- The UPS can be operated by any individuals with no previous experience.
- Connect the UPS system only to an earthed shockproof outlet which must be easily accessible and close to the UPS system.
- Please use only VDE-tested, CE-marked mains cable (e.g. the mains cable of your computer) to connect the UPS system to the building wiring outlet (shockproof outlet).
- Please use only VDE-tested, CE-marked power cables to connect the loads to the UPS system.
- When installing the equipment, it should ensure that the sum of the leakage current of the UPS and the connected devices does not exceed 3.5mA.

1-4. Operation

- Do not disconnect the mains cable on the UPS system or the building wiring outlet (shockproof socket outlet) during operations since this would cancel the protective earthing of the UPS system and of all connected loads.
- The UPS system features its own, internal current source (batteries). The UPS output sockets or output terminals block may be electrically live even if the UPS system is not connected to the building wiring outlet.
- In order to fully disconnect the UPS system, first press the OFF/Enter button to disconnect the mains.
- Prevent no fluids or other foreign objects from inside of the UPS system.

1-5. Maintenance, service and faults

- The UPS system operates with hazardous voltages. Repairs may be carried out only by qualified maintenance personnel.
- **Caution** - risk of electric shock. Even after the unit is disconnected from the mains (building wiring outlet), components inside the UPS system are still connected to the battery and electrically live and dangerous.
- Before carrying out any kind of service and/or maintenance, disconnect the batteries and verify that no current is present and no hazardous voltage exists in the terminals of high capability capacitor such as BUS-capacitors.
- Only persons are adequately familiar with batteries and with the required precautionary measures may replace batteries and supervise operations. Unauthorized persons must be kept well away from the batteries.
- **Caution** - risk of electric shock. The battery circuit is not isolated from the input voltage. Hazardous voltages may occur between the battery terminals and the ground. Before touching, please verify that no voltage is present!
- Batteries may cause electric shock and have a high short-circuit current. Please take the precautionary measures specified below and any other measures necessary when working with batteries:
 - remove wristwatches, rings and other metal objects
 - use only tools with insulated grips and handles.
- When changing batteries, install the same number and same type of batteries.
- Do not attempt to dispose of batteries by burning them. This could cause battery explosion.
- Do not open or destroy batteries. Escaping electrolyte can cause injury to the skin and eyes. It may be toxic.
- Please replace the fuse only with the same type and amperage in order to avoid fire hazards.
- Do not dismantle the UPS system.
- **WARNING:** This is a category C2 UPS product. In a residential environment, this product may cause radio interference, in which case the user may be required to take additional measures. (only for 220/230/240 VAC system)
- **WARNING:** Changes or modifications not expressly approved by the party responsible for compliance could void the user's authority to operate the equipment.

2. Installation and setup

NOTE: Before installation, please inspect the unit. Be sure that nothing inside the package is damaged. Please keep the original package in a safe place for future use.

2-1. Rear panel view

Tower model

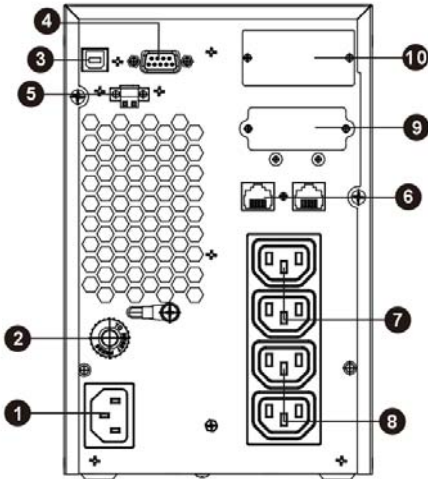

1K (TH)

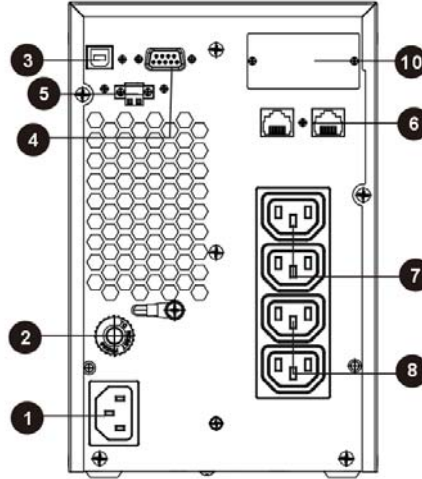

1K (THB)

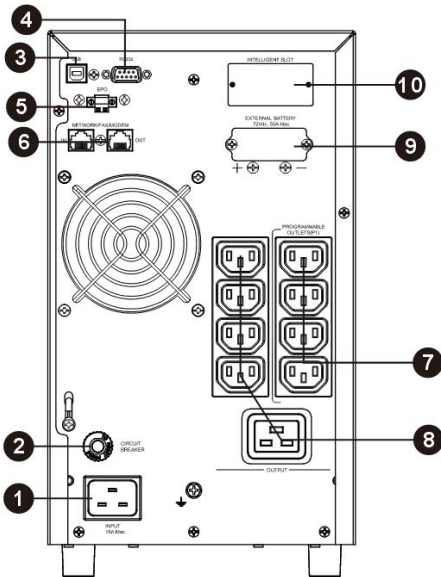

3K (TH)

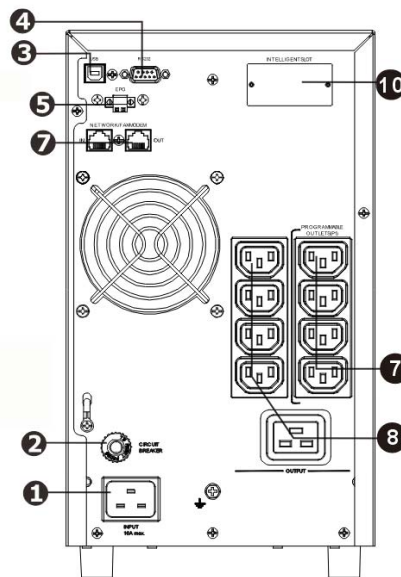

3K (THB)

RT model

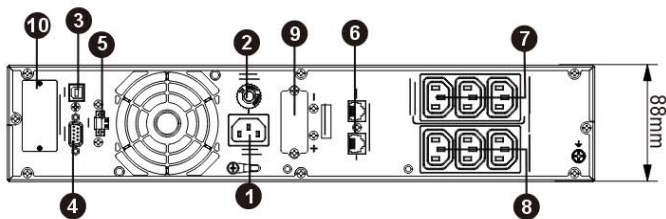

1K (RH)

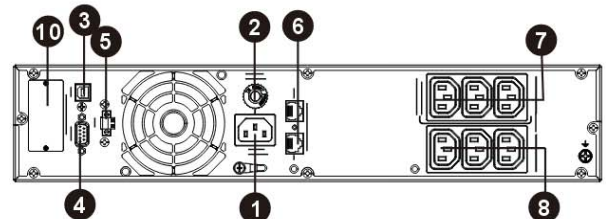

1K (RHB)

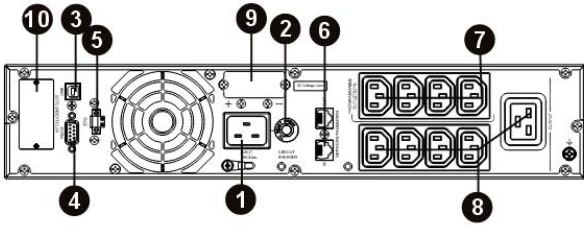

3K (RH)

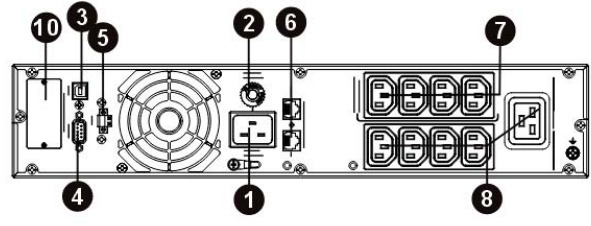

3K (RHB)

1. AC input
2. Input circuit breaker
3. USB communication port
4. RS-232 communication port
5. EPO port
6. Modem/Phone/Network surge protection
7. Programmable outlets: connect to non-critical loads.
8. Output receptacles
9. External battery interface(battery-free model)
10. Control Card Slot

2-2. Operating principle

The operating principle of the UPS is shown as below

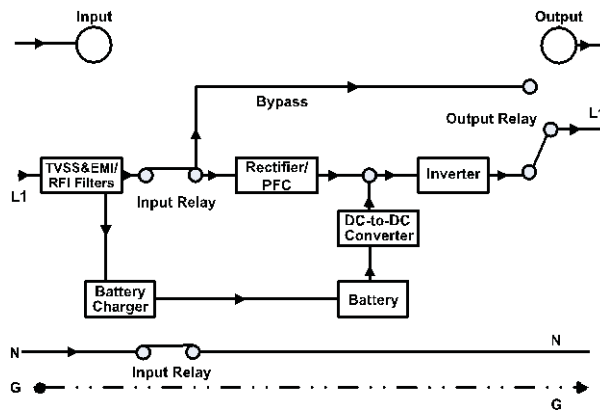

2-3. UPS Installation (Only available for Rack UPS)

Cabinet Installation

This UPS can be mounted in the 19" rack chassis. Please follow below steps to position this UPS.

Step 1

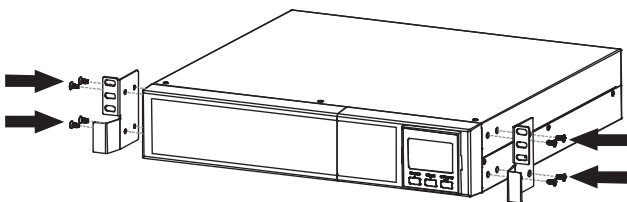

Vertical Installation

Step 2

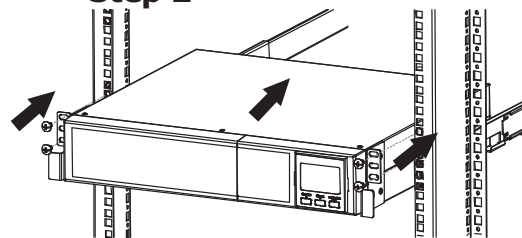

Step 1

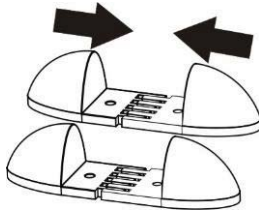

Step 2

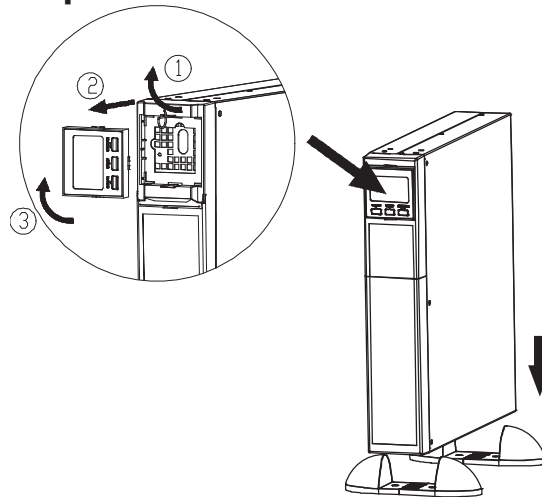

Step 3

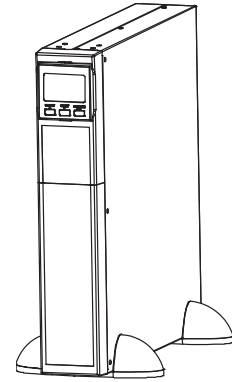

2-4. Setup the UPS

Before installing the UPS, please read below to select proper location to install UPS.

- UPS should be placed on the flat and clean surface. Place it in an area away from vibration, dust, humidity, high temperature, flammable liquids, gases, corrosive and conductive contaminants. Install the UPS indoors in a clean environment, where it is away from window and door. Maintain minimum clearance of 100mm in the bottom of the UPS to avoid dust and high temperature.

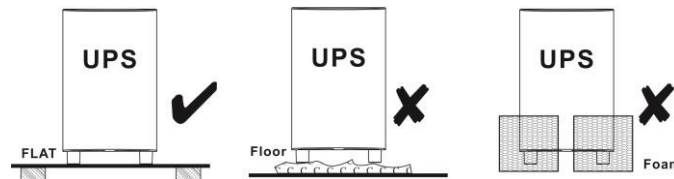

- Maintain an ambient temperature range of 0°C to 40°C for UPS optimal operation. UPS will derate to 80% when 40°C < Ambient Temp. < 50°C. The highest working temperature requirement for UPS operation is 50°C.
- It's required to maintain maximum altitude of 1000m to keep UPS normal operation at full load UPS. If it's used in high altitude area, please reduce connected load. Altitude derating power with connected loads for UPS normal operation is listed as below:

Altitude m	Derating factor ¹⁾
1 000	1.0
1 500	0.95
2 000	0.91
2 500	0.86
3 000	0.82
3 500	0.78
4 000	0.74
4 500	0.7
5 000	0.67

NOTE - Note to table 1
Based on density of dry air = 1.225 kg/m³ at sea-level, +15 °C.

¹⁾ Since fans lose efficiency with altitude, forced air-cooled equipment will have a smaller derating

4. Place UPS:

It's equipped with fan for cooling. Therefore, place the UPS in a well-ventilated area. It's required to maintain minimum clearance of 100mm in the front of the UPS and 300mm in the back and two sides of the UPS for heat dissipation and easy-maintenance.

5. Connect to External Battery Pack



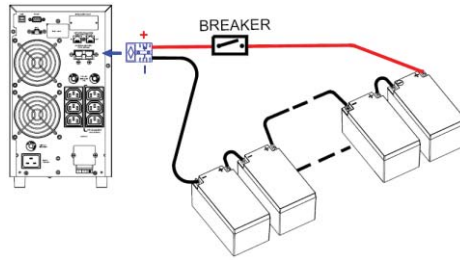

When connecting external battery packs, please be sure to connect polarity correctly. Connect positive pole of battery pack to positive pole of external battery connector in UPS and negative pole of battery pack to negative pole of external battery connector in UPS. Polarity misconnection will cause UPS internal fault. It's recommended to add one breaker between positive pole of battery pack and positive pole of external battery connector in UPS to prevent damage to battery packs from internal fault.

The required specification of breaker: voltage $\geq 1.25 \times$ battery voltage/set; current $\geq 50A$. Please choose battery size and connected numbers according to backup time requirement and UPS specifications. To extend battery lifecycle, it's recommended to use them in the temperature range of 15°C to 25°C.

Step 1: External battery connection

Follow the right chart to make external battery connection.

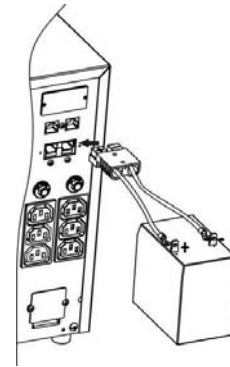

Step 2: UPS input connection

Plug the UPS into a two-pole, three-wire, grounded receptacle only. Avoid using extension cords.

- For 200/208/220/230/240VAC models: The power cord is supplied in the UPS package.

Step 3: UPS output connection

There two kinds of outputs: programmable outlets and general outlets. Please connect non-critical devices to the programmable outlets and critical devices to the general outlets. During power failure, you may extend the backup time to critical devices by setting shorter backup time for non-critical devices.

- For socket-type outputs, simply connect devices to the outlets.
- For terminal-type input or outputs, please follow below steps for the wiring configuration:
 - a) Remove the small cover of the terminal block
 - b) Suggest using AWG14 or 2.1mm² power cords for 3KVA (200/208/220/230/240VAC models). Please also install a 2-port breaker 16A, 250V for 3KVA 200/208/220/230/240VAC models between the mains and AC input of UPS for safety operation.
 - c) Upon completion of the wiring configuration, please check whether the wires are securely affixed.
 - d) Put the small cover back to the rear panel.

Step 4: Communication connection

Communication port:

USB port



RS-232 port

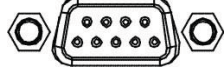

To allow for unattended UPS shutdown/start-up and status monitoring, connect the communication cable one end to the USB/RS-232 port and the other to the communication port of your PC. With the monitoring software installed, you can schedule UPS shutdown/start-up and monitor UPS status through PC.

PS. USB port and RS-232 port can work at the same time.

Step 5: Turn on the UPS

Press the ON/Mute button on the front panel for two seconds to power on the UPS.

Note: The battery charges fully during the first five hours of normal operation. Do not expect full battery run capability during this initial charge period.

Step 6: Install software

For optimal computer system protection, install UPS monitoring software to fully configure UPS shutdown. You may insert provided CD into CD-ROM to install the monitoring software. If not, please follow steps below to download and install monitoring software from the internet:

1. Go to the website <http://www.power-software-download.com>
2. Click ViewPower software icon and then choose your required OS to download the software.
3. Follow the on-screen instructions to install the software.
4. When your computer restarts, the monitoring software will appear as an orange plug icon located in the system tray, near the clock.









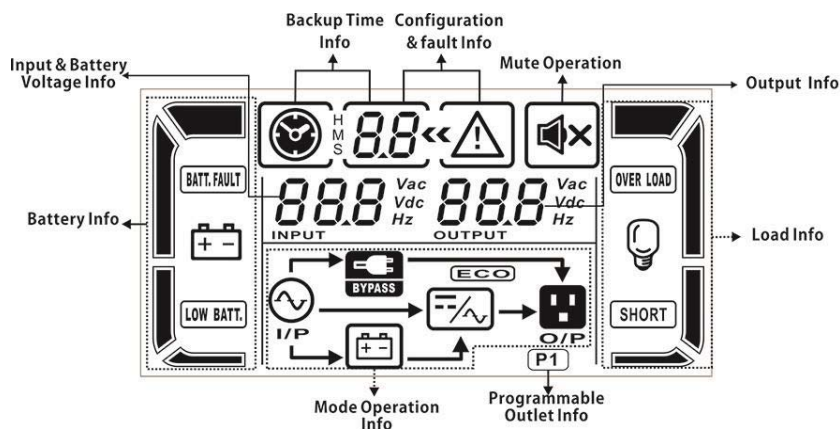











3. Operations

3-1. Button operation

Button	Function
ON/Mute Button	<ul style="list-style-type: none"> ➤ Turn on the UPS: Press and hold ON/Mute button for at least 2 seconds to turn on the UPS. ➤ Turn on the UPS: Press and hold ON/Mute button for at least 2 seconds to turn on the UPS. ➤ Up key: Press this button to display previous selection in UPS setting mode. ➤ Switch to UPS self-test mode: Press and hold ON/Mute button for 5 seconds to enter UPS self-testing while in AC mode, ECO mode, or converter mode.
OFF/Enter Button	<ul style="list-style-type: none"> ➤ Turn off the UPS: Press and hold this button at least 2 seconds to turn off the UPS. UPS will be in standby mode under power normal or transfer to Bypass mode if the Bypass enable setting by pressing this button. ➤ Confirm selection key: Press this button to confirm selection in UPS setting mode.
Select Button	<ul style="list-style-type: none"> ➤ Switch LCD message: Press this button to change the LCD message for input voltage, input frequency, battery voltage, output voltage and output frequency. It will return back to default display when pausing for 10 seconds. ➤ Setting mode: Press and hold this button for 5 seconds to enter UPS setting mode when UPS is in standby mode or bypass mode. ➤ Down key: Press this button to display next selection in UPS setting mode.
ON/Mute + Select Button	<ul style="list-style-type: none"> ➤ Switch to bypass mode: When the main power is normal, press ON/Mute and Select buttons simultaneously for 5 seconds. Then UPS will enter to bypass mode. This action will be ineffective when the input voltage is out of acceptable range.

3-2. LCD Panel



Display	Function
Remaining backup time information	
	Indicates the remaining backup time in pie chart.
H M S 	Indicates the remaining backup time in numbers. H: hours, M: minute, S: second
Fault information	
	Indicates that the warning and fault occurs.
	Indicates the warning and fault codes, and the codes are listed in details in 3-5 section.
Mute operation	
	Indicates that the UPS alarm is disabled.
Output & Battery voltage information	
	Indicates the output voltage, frequency or battery voltage. Vac: output voltage, Vdc: battery voltage, Hz: frequency
Load information	
	Indicates the load level by 0-25%, 26-50%, 51-75%, and 76-100%.
	Indicates overload.
	Indicates the load or the UPS output is short circuit.
Programmable outlets information	
	Indicates that programmable management outlets are working.
Mode operation information	
	Indicates the UPS connects to the mains.
	Indicates the battery is working.
	Indicates the bypass circuit is working.
	Indicates the ECO mode is enabled.
	Indicates the Inverter circuit is working.
	Indicates the output is working.
Battery information	
	Indicates the Battery level by 0-25%, 26-50%, 51-75%, and 76-100%.
	Indicates the battery is fault.
	Indicates low battery level and low battery voltage.
Input & Battery voltage information	
	Indicates the input voltage or frequency or battery voltage. Vac: Input voltage, Vdc: battery voltage, Hz: input frequency

3-3. Audible Alarm

Battery Mode	Sounding every 4 seconds
Low Battery	Sounding every second
Overload	Sounding twice every second
Fault	Continuously sounding
Bypass Mode	Sounding every 10 seconds

3-4. LCD display wordings index

Abbreviation	Display content	Meaning
ENA	<i>ENR</i>	Enable
DIS	<i>di S</i>	Disable
ESC	<i>ESC</i>	Escape
HLS	<i>HLS</i>	High loss
LLS	<i>LLS</i>	Low loss
BAT	<i>bAt</i>	Battery
CF	<i>CF</i>	Converter
TP	<i>tP</i>	Temperature
CH	<i>CH</i>	Charger
FU	<i>FU</i>	Bypass frequency unstable
EE	<i>EE</i>	EEPROM error
EP	<i>EP</i>	EPO

3-5. UPS Setting

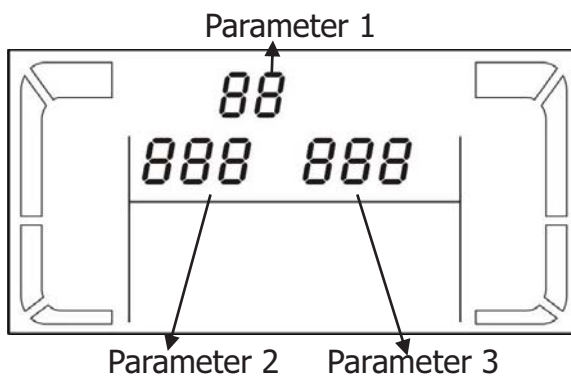

There are three parameters to set up the UPS.

Parameter 1: It's for program alternatives. Refer to below table. Parameter 2 and parameter 3 are the setting options or values for each program.

● 01: Output voltage setting

Interface	Setting
------------------	----------------

	<p>Parameter 3: Output voltage For 200/208/220/230/240 VAC models, you may choose the following output voltage: 200: presents output voltage is 200Vac 208: presents output voltage is 208Vac 220: presents output voltage is 220Vac 230: presents output voltage is 230Vac (Default) 240: presents output voltage is 240Vac</p>
---	--

● **02: Frequency Converter enable/disable**

Interface	Setting
	<p>Parameter 2 & 3: Enable or disable converter mode. You may choose the following two options: CF ENA: converter mode enable CF DIS: converter mode disable(Default)</p>

● **03: Output frequency setting**

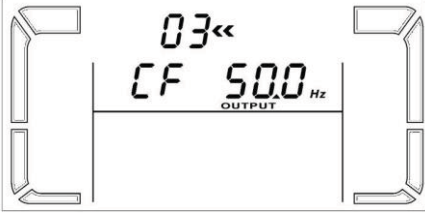
Interface	Setting
	<p>Parameter 2 & 3: Output frequency setting. You may set the initial frequency on battery mode: BAT 50: presents output frequency is 50Hz BAT 60: presents output frequency is 60Hz If converter mode is enabled, you may choose the following output frequency: CF 50: presents output frequency is 50Hz CF 60: presents output frequency is 60Hz</p>

● **04: ECO enable/disable**

Interface	Setting
	<p>Parameter 3: Enable or disable ECO function. You may choose the following two options: ENA: ECO mode enable DIS: ECO mode disable (Default)</p>

● **05: ECO voltage range setting**

Interface	Setting
	<p>Parameter 2 & 3: Set the acceptable high voltage point and low voltage point for ECO mode by pressing Down key or Up key. HLS: High loss voltage in ECO mode in parameter 2. For 200/208/220/230/240 VAC models, the setting range in parameter 3 is from +7V to +24V of the nominal voltage. (Default: +12V) LLS: Low loss voltage in ECO mode in parameter 2. For 200/208/220/230/240 VAC models, the setting range in parameter 3 is from -7V to -24V of the nominal voltage. (Default: -12V)</p>

● **06: Bypass enable/disable when UPS is off**

Interface	Setting
	<p>Parameter 3: Enable or disable Bypass function. You may choose the following two options:</p> <p>ENA: Bypass enable</p> <p>DIS: Bypass disable (Default)</p>

● **07: Bypass voltage range setting**

Interface	Setting
	<p>Parameter 2 & 3: Set the acceptable high voltage point and acceptable low voltage point for Bypass mode by pressing the Down key or Up key.</p> <p>HLS: Bypass high voltage point For 200/208/220/230/240 VAC models: 230-264: setting the high voltage point in parameter 3 from 230Vac to 264Vac. (Default: 264Vac)</p> <p>LLS: Bypass low voltage point For 200/208/220/230/240 VAC models: 170-220: setting the low voltage point in parameter 3 from 170Vac to 220Vac. (Default: 170Vac)</p>

● **08: Programmable outlets enable/disable**

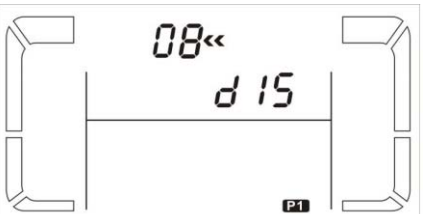
Interface	Setting
	<p>Parameter 3: Enable or disable programmable outlets.</p> <p>ENA: Programmable outlets enable</p> <p>DIS: Programmable outlets disable (Default)</p>

● **09: Programmable outlets setting**

Interface	Setting
	<p>Parameter 3: Set up backup time limits for programmable outlets.</p> <p>0-999: setting the backup time limits in minutes from 0-999 for programmable outlets which connect to non-critical devices on battery mode. (Default: 999)</p>

● **10: Autonomy limitation setting**

Interface	Setting
	<p>Parameter 3: Set up backup time on battery mode for general outlets.</p> <p>0-999: setting the backup time in minutes from 0-999 for general outlets on battery mode.</p> <p>0: When setting as "0", the backup time will be only 10 seconds.</p> <p>999: When setting as "999", the backup time setting will be disabled. (Default)</p>

● **11: Total battery AH**

Interface	Setting
-----------	---------

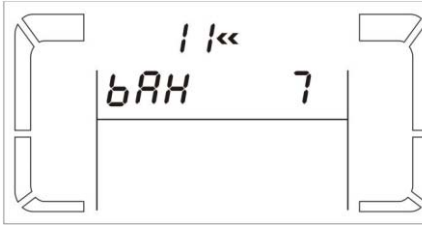
	<p>Parameter 3: Set up total battery AH value of the UPS. (unit: AH) 7-999: setting the total battery capacity from 7 to 999. Please set up this figure if external battery pack is connected. If the UPS is standard model, the default setting is 9AH. If the UPS is long-run model, the default setting is 65AH.</p>
---	--

● **12: Maximum charger current setting**

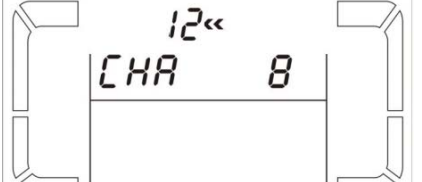
Interface	Setting
	<p>Parameter 3: Set up the maximum charger current. This setting is only available for long-run model. 1/2/4/6/8: setting the maximum charger current 1/2/4/6/8 in Ampere. (Default: 8A)</p>

● **13: Charger boost voltage setting**

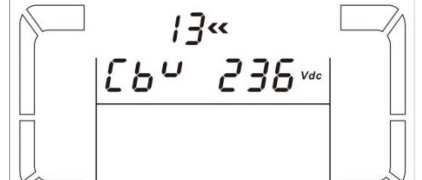
Interface	Setting
	<p>Parameter 3: Set up the charger boost voltage. 2.25-2.40: setting the charger boost voltage from 2.25 V/cell to 2.40V/cell. (Default: 2.36V/cell)</p>

● **14: Charger float voltage setting**

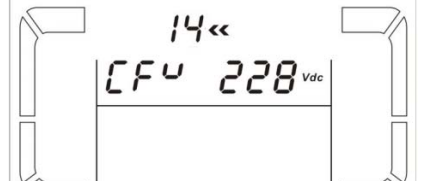
Interface	Setting
	<p>Parameter 3: Set up the charger float voltage. 2.20-2.33: setting the charger float voltage from 2.20 V/cell to 2.33V/cell. (Default: 2.28V/cell)</p>

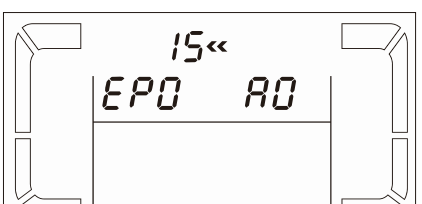

● **15: EPO logic setting**

Interface	Setting
	<p>Parameter 4: Set up the EPO function control logic. AO: Active Open (Default). When AO is selected as EPO logic, it will activate EPO function with Pin 1 and Pin 2 in open status. AC: Active Close. When AC is selected as EPO logic, it will activate EPO function with Pin 1 and Pin 2 in close status.</p>



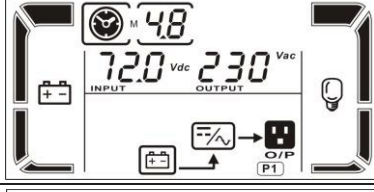
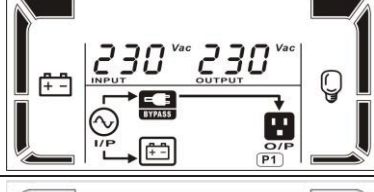
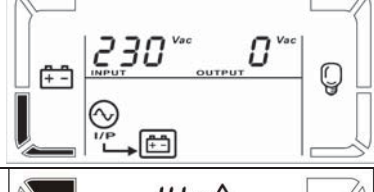
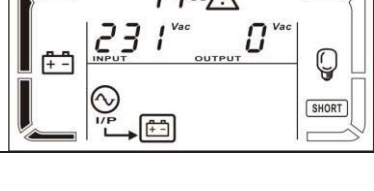

● **00: Exit setting**

3-6.Operating Mode Description







Operating mode	Description	LCD display
Online mode	When the input voltage is within acceptable range, UPS will provide pure and stable AC power to output. The UPS will also charge the battery at online mode.	











ECO mode	Energy saving mode: When the input voltage is within voltage regulation range, UPS will bypass voltage to output for energy saving.	
Frequency Converter mode	When input frequency is within 40 Hz to 70 Hz, the UPS can be set at a constant output frequency, 50 Hz or 60 Hz. The UPS will still charge battery under this mode.	
Battery mode	When the input voltage is beyond the acceptable range or power failure and alarm is sounding every 4 second, UPS will backup power from battery.	
Bypass mode	When input voltage is within acceptable range but UPS is overload, UPS will enter bypass mode or bypass mode can be set by front panel. Alarm is sounding every 10 second.	
Standby mode	UPS is powered off and no output supply power, but still can charge batteries.	
Fault mode	When a fault has occurred, the ERROR icon and the fault code will be displayed.	

3-7. Faults Reference Code

Fault event	Fault code	Icon	Fault event	Fault code	Icon
Bus start fail	01	x	Inverter output short	14	
Bus over	02	x	Battery voltage too high	27	
Bus under	03	x	Battery voltage too low	28	
Bus unbalance	04	x	Over temperature	41	x
Inverter soft start failure	11	x	Overload	43	
Inverter voltage high	12	x	Charger failure	45	x
Inverter voltage Low	13	x			







3-8. Warning indicator

Warning	Icon (flashing)	Alarm
Low Battery	 	Sounding every second
Overload	 	Sounding twice every second
Battery is not connected	 	Sounding every second

Over Charge		Sounding every second
Over temperature	<i>EP</i> 	Sounding every second
Charger failure	<i>CH</i> 	Sounding every second
Battery fault	 	Sounding every second
Out of bypass voltage range	 	Sounding every second
Bypass frequency unstable	<i>FU</i> 	Sounding every second
EEPROM error	<i>EE</i> 	Sounding every second
EPO enable	<i>EP</i> 	Sounding every second

4. Troubleshooting

If the UPS system does not operate correctly, please solve the problem by using the table below.

Symptom	Possible cause	Remedy
No indication and alarm even though the mains is normal.	The AC input power is not connected well.	Check if input power cord firmly connected to the mains.
	The AC input is connected to the UPS output.	Plug AC input power cord to AC input correctly.
The icon  and the warning <i>EP</i> flashing on LCD display. Alarm is sounding every second.	EPO function is activated.	Set the circuit in closed position to disable EPO function.
The icon  and  flashing on LCD display and alarm is sounding every second.	The external or internal battery is incorrectly connected.	Check if all batteries are connected well.
Fault code is shown as 27 and the icon  is lighting on LCD display and alarm is continuously sounding.	Battery voltage is too high or the charger is fault.	Contact your dealer.
Fault code is shown as 28 and the icon  is lighting on LCD display and alarm is continuously sounding.	Battery voltage is too low or the charger is fault.	Contact your dealer.
The icon  and  is flashing on LCD display and alarm is sounding twice every second.	UPS is overload	Remove excess loads from UPS output.
	UPS is overloaded. Devices connected to the UPS are fed directly by the electrical network via the Bypass.	
	After repetitive overloads, the UPS is locked in the	Remove excess loads from UPS output first. Then shut

	Bypass mode. Connected devices are fed directly by the mains.	down the UPS and restart it.
Fault code is shown as 43 and The icon OVER LOAD is lighting on LCD display and alarm is continuously sounding.	The UPS shut down automatically because of overload at the UPS output.	Remove excess loads from UPS output and restart it.
Fault code is shown as 14 and the icon SHORT is lighting on LCD display and alarm is continuously sounding.	The UPS shut down automatically because short circuit occurs on the UPS output.	Check output wiring and if connected devices are in short circuit status.
Fault code is shown as 01, 02, 03, 04, 11, 12, 13, 41 and 45 on LCD display and alarm is continuously sounding.	A UPS internal fault has occurred. There are two possible results: 1. The load is still supplied, but directly from AC power via bypass. 2. The load is no longer supplied by power.	Contact your dealer
Battery backup time is shorter than nominal value	Batteries are not fully charged	Charge the batteries for at least 5 hours and then check capacity. If the problem still persists, consult your dealer.
	Batteries defect	Contact your dealer to replace the battery.

5. Storage and Maintenance

Operation

The UPS system contains no user-serviceable parts. If the battery service life (3~5 years at 25°C ambient temperature) has been exceeded, the batteries must be replaced. In this case, please contact your dealer.



Be sure to deliver the spent battery to a recycling facility or ship it to your dealer in the replacement battery packing material.

Before storing, charge the UPS 5 hours. Store the UPS covered and upright in a cool, dry location. During storage, recharge the battery in accordance with the following table:

Storage Temperature	Recharge Frequency	Charging Duration
-25°C - 40°C	Every 3 months	1-2 hours
40°C - 45°C	Every 2 months	1-2 hours

目录

1. 重要安全警告.....	18
1-1. 运输.....	18
1-2. 准备工作.....	18
1-3. 安装.....	18
1-4. 操作.....	18
1-5. 维护、服务和故障.....	18
2. 安装与设置.....	20
2-1. 后视图.....	20
2-2. 工作原理.....	21
2-3. UPS 安装（仅适用于机架式）.....	21
2-4. UPS 设置.....	22
3. 操作.....	24
3-2. LCD 面板.....	25
3-3. 声音报警.....	26
3-4. LCD 显示文字索引.....	26
3-5. UPS 设置.....	27
3-6. 运行模式说明.....	31
3-7. 故障参考代码.....	32
3-8. 警告指示灯.....	32
4. 故障排除.....	32
5. 存储与维护.....	34

1. 重要安全警告

请严格遵守本手册中的所有警告和操作说明。请妥善保存本手册，并在安装本设备前仔细阅读以下说明。在未仔细阅读所有安全信息和操作说明之前，请勿操作本设备。

1-1. 运输

- 请仅以原始包装运输 UPS 系统，以防止震动和冲击。

1-2. 准备工作

- 如果UPS系统直接从寒冷环境移动到温暖环境，则可能会发生冷凝。安装前，UPS系统必须绝对干燥。请至少留出两个小时让UPS系统适应环境。
- 请勿将UPS系统安装在靠近水或潮湿的环境中。
- 请勿将UPS系统安装在阳光直射或靠近加热器的地方。
- 请勿堵塞 UPS 外壳中的通风孔。

1-3. 安装

- 请勿将可能使UPS系统过载的电器或设备（如激光打印机）连接到UPS输出插座。
- 将电缆放置在没有人会踩到或绊倒的地方。
- 请勿将吹风机等家用电器连接到UPS输出插座。
- UPS可以由任何没有经验的人操作。
- 仅将UPS系统连接到接地防震插座，该插座必须易于接近并靠近UPS系统。
- 请仅使用经过VDE测试、CE标志的电源线（例如计算机的电源线）将UPS系统连接到建筑接线插座（防震插座）。
- 请仅使用经过VDE测试、CE标志的电源线将负载连接到UPS系统。
- 安装设备时，应确保UPS和连接设备的漏电流之和不超过 3.5mA。

1-4. 操作

- 操作期间，不要断开UPS系统或建筑物接线插座（防震插座）上的电源电缆，因为这会取消UPS系统和所有连接负载的保护接地。
- UPS系统具有自己的内部电流源（电池）。即使UPS系统未连接到建筑物的接线插座，UPS输出插座或输出端子板也可能带电。
- 为了完全断开UPS系统，首先按OFF/Enter按钮断开电源。
- 防止液体或其他异物进入UPS系统内部。

1-5. 维护、服务和故障

- UPS系统在危险电压下运行。只能由合格的维护人员进行维修。
- 小心-有触电危险。即使在该装置与电源（建筑接线插座）断开连接后，UPS系统内的组件仍与电池相连，带电且危险。
- 在进行任何类型的维修和/或维护之前，断开蓄电池，并确认总线电容器等高容量电容器的端子中没有电流，也没有危险电压。
- 只有充分熟悉电池和所需预防措施的人员才能更换电池并监督操作。未经授权的人员必须远离电池。
- 小心-有触电危险。蓄电池电路未与输入电压隔离。蓄电池端子和接地之间可能会出现危险电压。在触摸之前，请确认没有电压存在！
- 电池可能会导致触电，并具有高短路电流。使用电池时，请采取以下规定的预防措施和任何其他必要措施：
 - 取下手表、戒指和其他金属物体
 - 仅使用带有绝缘握把和手柄的工具。

- 更换电池时，请安装相同数量和相同类型的电池。
- 不要试图通过燃烧电池来处理电池。这可能会导致电池爆炸。
- 请勿打开或损坏电池。电解液溢出会对皮肤和眼睛造成伤害。它可能有毒。
- 请仅用相同类型和电流更换保险丝，以避免火灾隐患。
- 请勿拆卸 UPS 系统。
- 警告：这是 C2 类 UPS 产品。在住宅环境中，本产品可能会造成无线电干扰，在这种情况下，用户可能需要采取额外措施。（仅适用于 220/230/240 VAC 系统）
- 警告：未经负责合规的一方明确批准的更改或修改可能会使用户操作设备的权限无效。

2. 安装与设置

注意：安装前请检查设备，确保包装内物品完好无损。请妥善保存原包装以备日后使用。

2-1. 后视图

塔式结构

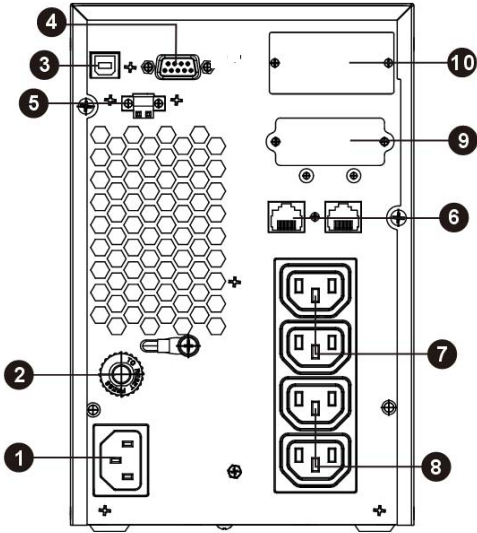

1K (TH)

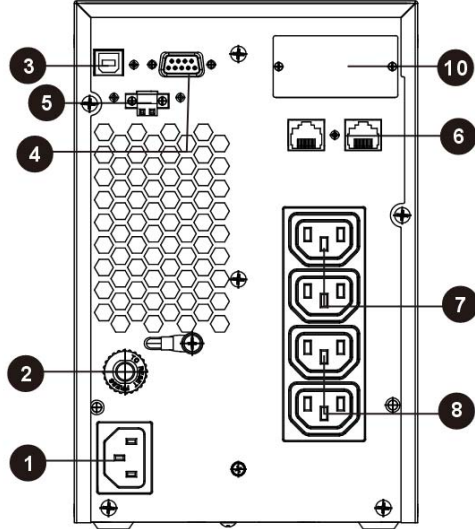

1K (THB)

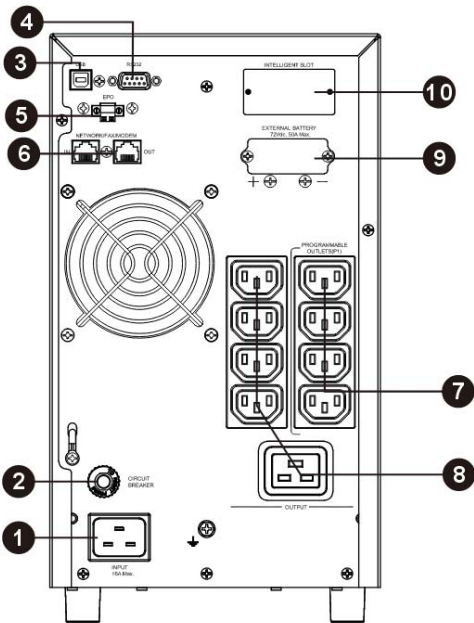

3K (TH)

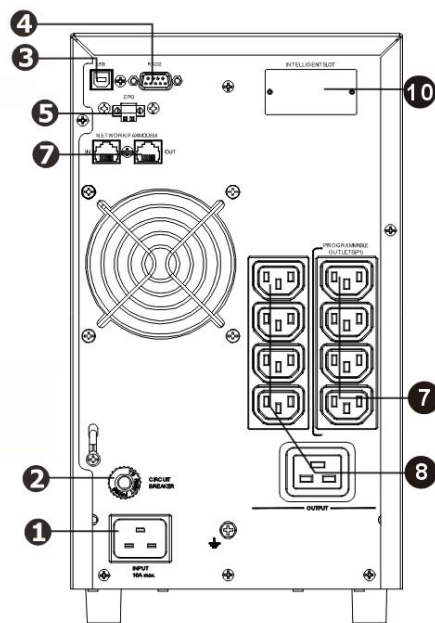

3K (THB)

机架式结构

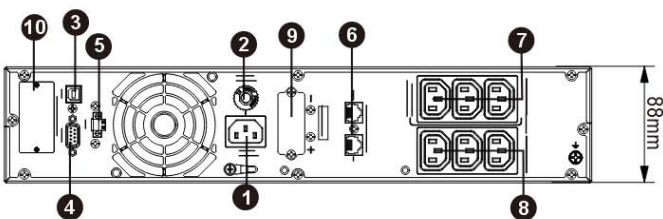

1K (RH)

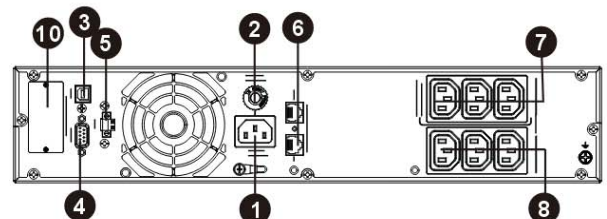

1K (RHB)

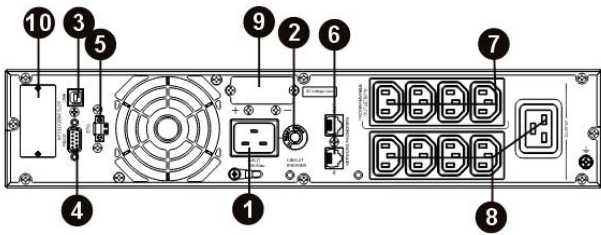

3K (RH)

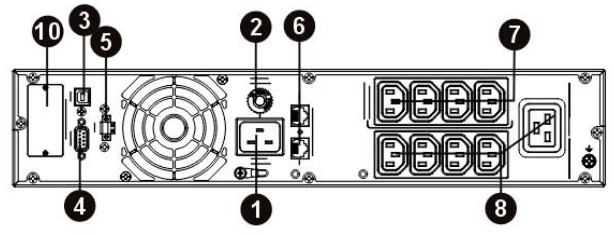

3K (RHB)

1. AC 输入
2. 输入断路器
3. USB 通信端口
4. RS-232 通信端口
5. 紧急断电 (EPO) 端口
6. 调制解调器/电话/网络浪涌保护
7. 可编程输出插座: 连接非关键负载
8. 输出插座
9. 电池外接接口 (无内置电池机型)
10. 控制卡插槽

2-2. 工作原理

UPS 工作原理如下所示

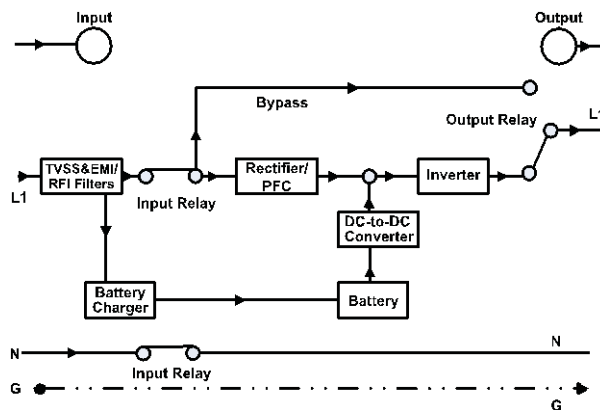

2-3. UPS 安装 (仅适用于机架式)

机柜安装

本 UPS 符合 19 英寸标准机架安装规范, 安装步骤如下

步骤 1

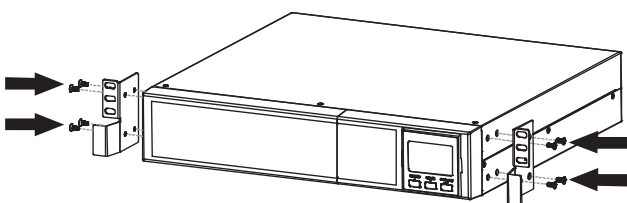

立式安装

步骤 2

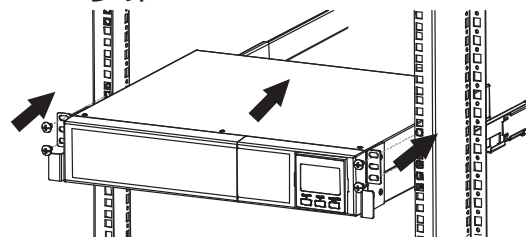

步骤 1

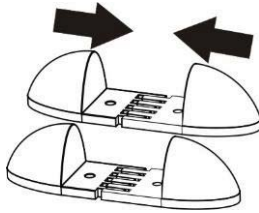

步骤 2

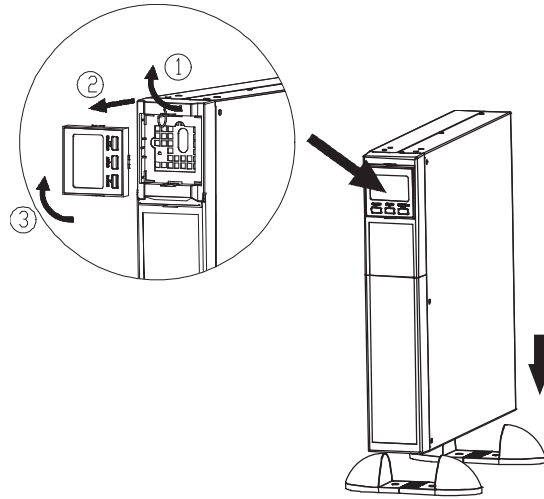

步骤 3

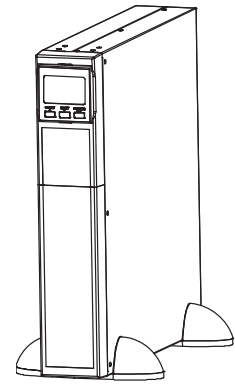

2-4. UPS 设置

安装 UPS 前请仔细阅读选址要求

1. 必须将 UPS 放置在平整洁净的表面上。远离振动、粉尘、潮湿、高温区域。严禁靠近易燃液体、气体及腐蚀性/导电污染物。需在清洁的室内环境安装，避开门窗位置。设备底部需保持 $\geq 100\text{mm}$ 离地间隙，防止积尘和高温

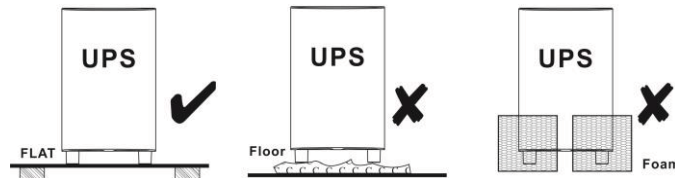

2. 保持 UPS 最佳操作的环境温度范围在 0°C 到 40°C 之间。当环境温度在 40°C 到 50°C 之间时，UPS 的额定功率将降至 80%。UPS 操作的最高工作温度要求为 50°C 。
3. 在 UPS 满载正常运行的情况下，要求维持最大高度为 1000 米。如果在高海拔地区使用，请减少连接负载。UPS 正常运行的高度降额功率及连接负载如下所示：

Altitude m	Derating factor ⁽¹⁾
1 000	1.0
1 500	0.95
2 000	0.91
2 500	0.86
3 000	0.82
3 500	0.78
4 000	0.74
4 500	0.7
5 000	0.67

NOTE - Note to table 1
Based on density of dry air = 1.225 kg/m^3 at sea-level, $+15^{\circ}\text{C}$.

⁽¹⁾ Since fans lose efficiency with altitude, forced air-cooled equipment will have a smaller derating

4. UPS 放置

本设备配备冷却风扇。因此，请将 UPS 放置在通风良好的区域，要求在 UPS 前面保持至少 100 毫米的间隙，后面和两侧保持 300 毫米的间隙，以便散热和方便维护。

5. 外部电池组连接



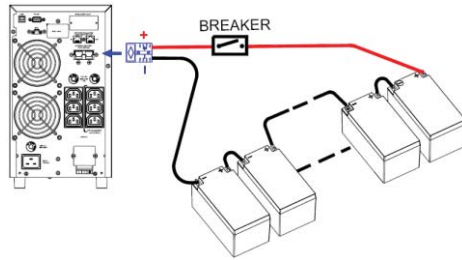

连接外部电池组时，请务必正确连接极性。将电池组的正极连接到 UPS 外部电池连接器的正极，将电池组的负极连接到 UPS 外部电池连接器的负极。极性连接错误会导致 UPS 内部故障。建议在电池组的正极与 UPS 外部电池连接器的正极之间增加一个断路器，以防止由于内部故障而对电池组造成损害。断路器的要求规格：电压 $\geq 1.25 \times$ 电池电压/套；电流 $\geq 50A$ 请根据备用时间要求和 UPS 规格选择电池大小和连接数量。为了延长电池寿命，建议在 15°C 到 25°C 的温度范围内使用它们。

步骤一：外部电池连接

按照正确的图表进行外部电池连接。

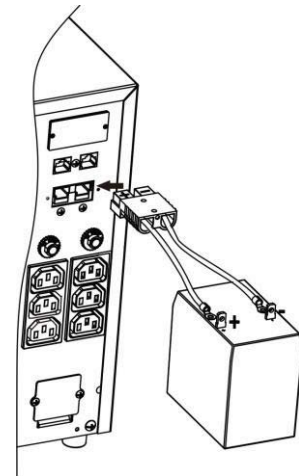

步骤二：UPS 输入连接

将不间断电源（UPS）插入双极、三线接地插座。避免使用延长线。

- 对于200/208/220/230/240VAC型号：电源线随不间断电源包装提供

步骤三：UPS 输出连接

输出分为两种：可编程插座和普通插座。请将非关键设备连接到可编程插座，将关键设备连接到普通插座。在停电期间，您可以通过为非关键设备设置较短的备用时间来延长关键设备的备用时间。

- 对于插座型输出，只需将设备连接到插座。
- 对于端子型输入或输出，请按照以下步骤进行接线配置：
 - a) 对于端子型输入或输出，请按照以下步骤进行接线配置。

- b) 建议为 3KVA (200/208/220/230/240VAC 型号) 使用 AWG14 或 2.1mm²电源线。请在 UPS 的主电源与交流输入之间安装一个 16A, 250V 的双口断路器, 以确保安全操作。
- c) 在完成接线配置后, 请检查导线是否固定牢靠。
- d) 将小盖放回后面板。

步骤四: 通信连接

链接端口

USB 端口



RS-232 端口

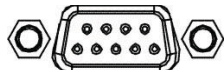

为了允许无人值守的 UPS 关闭/启动和状态监控, 将通信电缆的一端连接到 USB/RS-232 端口, 另一端连接到您计算机的通信端口。在安装监控软件后, 您可以通过计算机安排 UPS 的关闭/启动并监控 UPS 状态。

PS: USB 端口和 RS-232 端口可以同时工作。

步骤五: 打开 UPS

按下前面板上的开/静音按钮两秒钟以打开 UPS。

注意: 电池在正常操作的前五小时内充满电。在此初始充电期间, 请不要期待电池完全放电的能力。

步骤六: 安装软件

为了获得最佳的计算机系统保护, 请安装 UPS 监控软件以完全配置 UPS 关机。您可以将提供的 CD 插入光驱来安装监控软件。如果没有, 请按照以下步骤从互联网下载并安装监控软件:

1. 访问网站 <http://www.power-software-download.com>
2. 点击 ViewPower 软件图标, 然后选择您需要的操作系统下载软件。
3. 按照屏幕上的说明安装软件。
4. 当计算机重新启动时, 监控软件将以一个橙色插头图标的形式出现在系统托盘中, 在时钟附近。

3. 操作

3-1. 按键操作







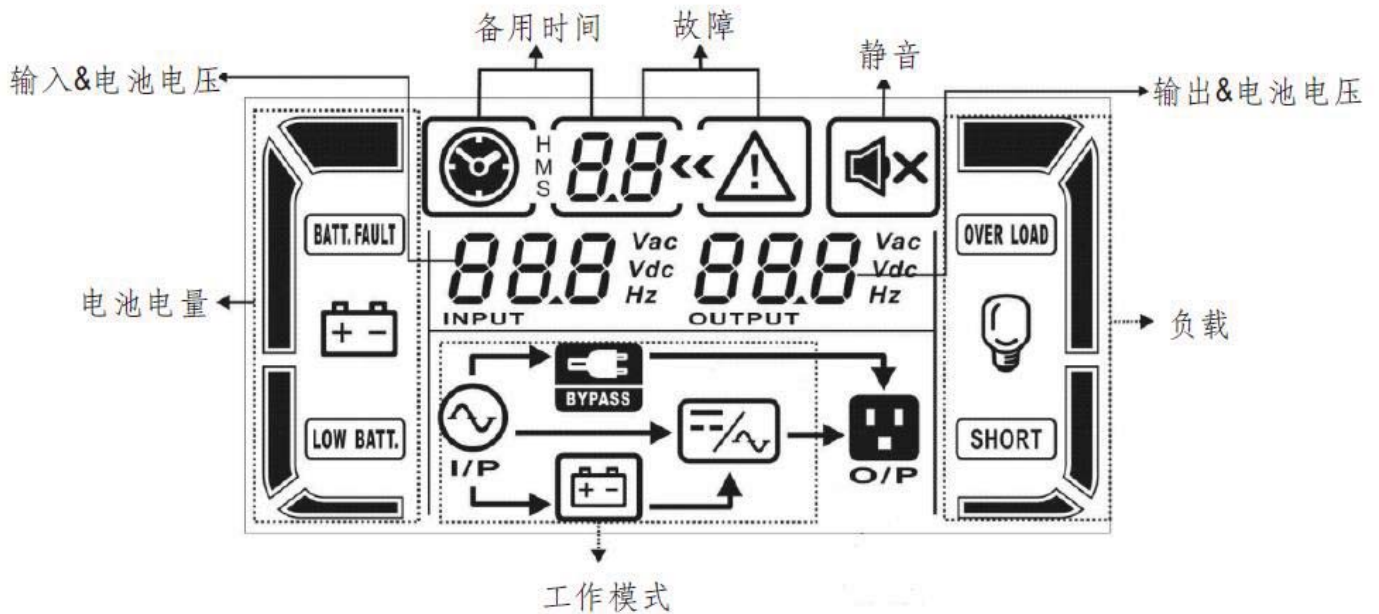

按钮	功能
ON/Mute Button	<ul style="list-style-type: none"> ➢ 打开UPS: 按住ON/Mute按钮至少2秒以打开不间断电源 (UPS)。 ➢ 静音报警: 当UPS处于电池模式时, 长按此按钮至少5秒以禁止或启用报警系统, 但该功能不适用于出现警告或错误情况时。 ➢ 上键: 按下此按钮可在UPS设置模式中显示先前的选择。 ➢ 切换到UPS自检模式: 在交流模式、节能模式或变换器模式下, 长按 ON/Mute按钮5秒钟以进入UPS自检。
OFF/Enter Button	<ul style="list-style-type: none"> ➢ 关闭UPS: 按住此按钮至少2秒以关闭UPS。在电源正常情况下, UPS将进入待机模式, 如果通过按下该按钮将UPS设置为旁路模式, 则UPS将切换到旁路模式。 ➢ 确认选择键: 按下此按钮以确认在UPS设置模式中的选项。
Select Button	<ul style="list-style-type: none"> ➢ 切换LCD 消息: 按下此按钮以更改输入电压、输入频率、电池电压、输出电压和输出频率的LCD显示信息。当暂停 10 秒后, 将返回默认显示

	状态。 ➢ 设置模式: 在 UPS 处于待机模式或旁路模式时, 长按此按钮 5 秒以进入 UPS 设置模式 ➢ 下键: 在 UPS 设置模式下按此按钮以显示下一个选项。
ON/Mute+Select Button	➢ 切换到旁路模式: 当主电源正常时, 同时按下ON/Mute+Select按钮持续5秒。然后UPS将自动进入旁路模式。当输入电压超出可接受范围时, 此操作将无效。

3-2. LCD 面板



显示	功能
剩余备份时间信息	
	在饼图中指示剩余的备份时间
H M S 8.8	以数字表示剩余备份时间 H: 小时, M: 分钟, S: 秒
故障信息	
	表示警告和故障发生
8.8	指示警告和故障代码, 详细代码列在第3-5节中
静音操作	
	表示UPS警报已禁用
输出和电池电压信息	
8.8.8 Vac Vdc Hz OUTPUT	表示输出电压、频率或电池电压 Vac: 输出电压, Vdc: 电池电压, Hz: 频率
加载信息	

	通过0-25%，26-50%，51-75%和76-100%来指示负载水平
OVER LOAD	表示过载
SHORT	指示负载或UPS输出短路
可编程插座信息	
P1	表示可编程管理插座正在工作
模式操作信息	
	表示UPS连接到电源
	指示电池正在工作
	表示旁路电路正在工作
ECO	表示ECO模式已启用
	表示逆变器电路正在工作
	表示输出正常工作
电池信息	
	通过0-25%，26-50%，51-75%和76-100%来指示电池电量
BATT. FAULT	表示电池有故障
LOW BATT.	表示电池电量低和电池电压低
输入和电池电压信息	
	指示输入电压、频率或电池电压 Vac: 输入电压, Vdc: 电池电压, Hz: 输入频率

3-3. 声音报警

电池模式	每 4 秒发出声音
电池电量低	每秒发出声音
超载	每秒发出两次声音
故障	持续发声
故障模式	每 10 秒发出声音

3-4. LCD 显示文字索引

缩写	显示内容	意义
ENA	<i>ENA</i>	启用
DIS	<i>DIS</i>	禁用
ESC	<i>ESC</i>	逃脱
HLS	<i>HLS</i>	高损失

LLS	LLS	低损耗
BAT	bAt	电池
CF	CF	转换器
TP	tP	温度
CH	CH	充电器
FU	FU	旁路频率不稳定
EE	EE	EEPROM 错误
EP	EP	EPO

3-5. UPS 设置

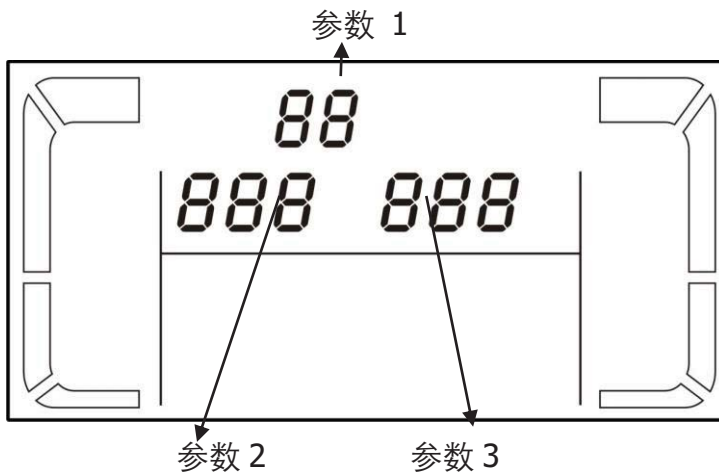

设置 UPS 有三个参数。

参数 1: 它用于程序替代方案。请参阅下表。

参数 2 和参数 3 是每个程序的设置选项或值。

● 01. 输出电压设定

界面	设置
	<p>参数 3: 输出电压</p> <p>对于 200/208/220/230/240 VAC 型号, 您可以选择以下输出电压:</p> <p>200: 表示输出电压为 200Vac</p> <p>208: 表示输出电压为 208Vac</p> <p>220: 表示输出电压为 220Vac</p> <p>230: 表示输出电压为 230Vac (默认)</p> <p>240: 表示输出电压为 240Vac</p>

● 02. 变频器启用/禁用

界面	设置
----	----

	<p>参数 2 & 3: 启用或禁用转换器模式。您可以选择以下两个选项:</p> <p>CF ENA: 转换器模式启用</p> <p>CF DIS: 转换器模式禁用 (默认)</p>
--	--

● 03. 输出频率设置

<p>界面</p>	<p>设置</p>
	<p>参数 2 & 3: 输出频率设置。</p> <p>您可以在电池模式下设置初始频率:</p> <p>BAT 50: 呈现输出频率为 50Hz</p> <p>BAT 60: 呈现输出频率为 60Hz</p> <p>如果启用了转换器模式, 您可以选择以下输出频率:</p> <p>CF 50: 呈现输出频率为 50Hz</p> <p>CF 60: 表示输出频率为 60Hz</p>

● 04. ECO 启用/禁用

<p>界面</p>	<p>设置</p>
	<p>参数3: 启用或禁用 ECO 功能。您可以选择以下两个选项:</p> <p>ENA: ECO 模式启用</p> <p>DIS: ECO 模式禁用 (默认)</p>

● 05. ECO 电压范围设置

<p>界面</p>	<p>设置</p>
	<p>参数2和3: 通过按下下键或上键, 为ECO模式设置可接受的高压点和低电压点。</p> <p>HLS: 参数 2 中 ECO 模式下的高损耗电压。</p> <p>对于 200/208/220/230/240 VAC 型号, 参数 3 中的设置范围为标称电压的 7V 至 24V。(默认: 12V)</p> <p>LLS: 参数 2 中 ECO 模式下的低损耗电压。</p> <p>对于 200/208/220/230/240 VAC 型号, 参数 3 中的设置范围为标称电压的 -7V 至 -24V。(默认: -12V)</p>

● 06. UPS 关闭时旁路启用/禁用

<p>界面</p>	<p>设置</p>
	<p>参数3: 启用或禁用 Bypass 功能。您可以选择以下两个选项:</p> <p>ENA: 旁路启用</p> <p>DIS: 绕过禁用 (默认)</p>

● 07. 旁路电压范围设置

<p>界面</p>	<p>设置</p>
	<p>参数2和3: 通过按下向下键或向上键, 为旁路模式设置可接受的高压点和可接受的低电压点。</p> <p>HLS: 旁路高压点</p> <p>对于 200/208/220/230/240 VAC 型号</p> <p>230-264: 将参数 3 中的高压点设置为 230Vac 至</p>

	264Vac。 (默认: 264Vac) LLS: 旁路低电压点对于 200/208/220/230/240 VAC 型号 170-220: 将参数 3 中的低电压点设置为 170Vac 至 220Vac。 (默认: 170Vac)
--	--

● 08. 可编程插座启用/禁用

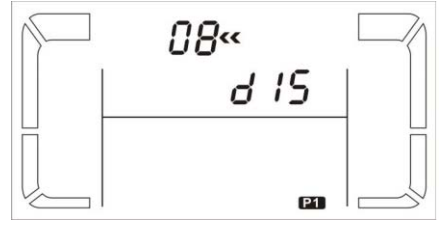
界面	设置
	参数3: 启用或禁用可编程插座。 ENA: 可编程插座启用 DIS: 可编程插座禁用 (默认)

● 9. 可编程插座设置

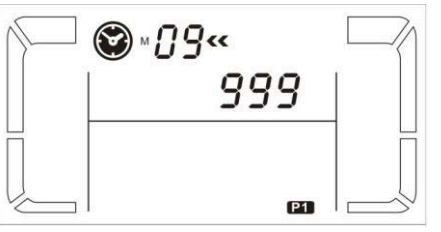
界面	设置
	参数3: 为可编程插座设置备份时间限制。 0-999: 为在电池模式下连接到非关键设备的可编程插座设置备用时间限制 (以分钟为单位), 范围为 0-999。 (默认值: 999)

● 自主限制设置

界面	设置
	参数3: 为一般插座设置电池模式的备份时间。 0-999: 在电池模式下, 将一般插座的备用时间 (以分钟为单位) 设置为 0-999。 0: 设置为“0”时, 备份时间仅为 10 秒。 999: 当设置为“999”时, 备份时间设置将被禁用。 (默认)

● 11. 总电池 AH

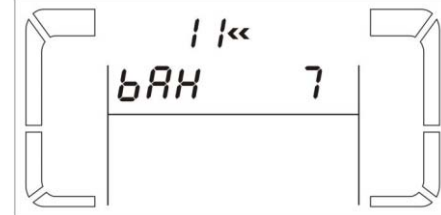
界面	设置
	参数3: 设置 UPS 的总电池 AH 值。 (单位: AH) 7-999: 将电池总容量设置为 7 到 999。如果连接了外部电池组, 请设置此图。 如果 UPS 是标准型号, 则默认设置为 9AH。 如果 UPS 是长期运行型号, 则默认设置为 65AH。

● 12. 最大充电器电流设置

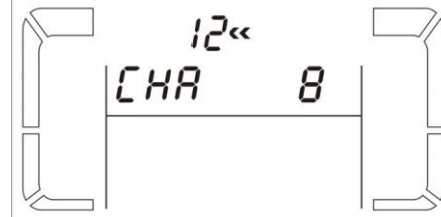
界面	设置
	参数3: 设置最大充电器电流。此设置仅适用于长期模型。 1/2/4/6/8: 将最大充电器电流设置为 1/2/4/6/8 英寸, 单位为安培。 (默认: 8A)

● 13. 充电器升压电压设置

界面	设置
----	----

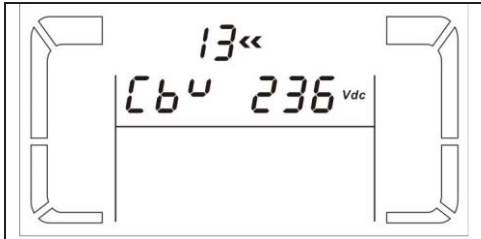

参数 3: 设置充电器升压。

2.25-2.40: 将充电器升压从 2.25 V/cell 设置为 2.40V/cell。(默认: 2.36V/节)

● 14. 充电器浮动电压设置

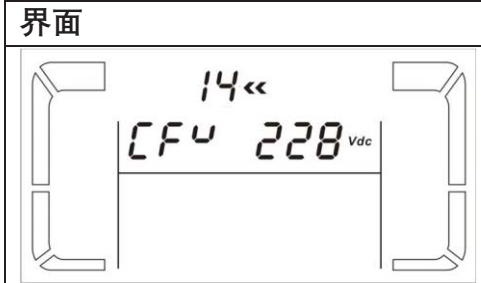

设置

参数 3: 设置充电器浮动电压。

2.20-2.33: 将充电器浮动电压从 2.20 V/cell 设置为 2.33V/cell。(默认: 2.28V/节)

● 15. EPO 逻辑设置

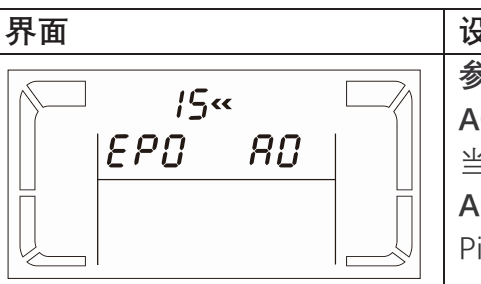

设置

参数4: 设置 EPO 功能控制逻辑。

AO: Active Open (默认)。当 AO 被选为 EPO 逻辑时, 当 Pin 1 和 Pin 2 处于打开状态时, 它将激活 EPO 功能。

AC: 主动关闭。当选择 AC 作为 EPO 逻辑时, 当 Pin 1 和 Pin 2 处于闭合状态时, 它将激活 EPO 功能

● 00: 退出设置

3-6. 运行模式说明

运行模式	描述	LCD 显示
在线模式	当输入电压在可接受的范围内时, UPS 将提供纯净稳定的交流电源来输出。UPS 还将在在线模式下为电池充电	
ECO 模式	节能模式: 当输入电压在电压调节范围内时, UPS 将旁路电压输出以节省能源	
变频器模式	当输入频率在 40 Hz 至 70 Hz 之间时, UPS 可以设置为恒定的输出频率, 即 50 Hz 或 60 Hz。在此模式下, UPS 仍将为电池充电。	
电池模式	当输入电压超出可接受范围或停电且每 4 秒响起警报时, UPS 将从电池备份电源。	
旁路模式	当输入电压在可接受范围内但 UPS 过载时, UPS 将进入旁路模式或可通过前面板设置旁路模式。警报每 10 秒响一次	
待机模式	UPS 断电且无输出供电, 但仍可为电池充电	
故障模式	发生故障时, 将显示 ERROR 图标和故障代码	

3-7. 故障参考代码

故障事件	故障码	图标	故障事件	故障码	图标
总线启动失败	01	x	逆变器输出短路	14	
总线过载	02	x	电池电压过高	27	
总线欠载	03	x	电池电压过低	28	
总线失衡	04	x	过温	41	x
逆变器软启动失败	11	x	超载	43	
逆变器电压高	12	x	充电器故障	45	x
逆变器电压 低	13	x			

3-8. 警告指示灯

警告	图标 (闪烁)	报警
电池电量低		每秒鸣响一次
超载		每秒鸣响两次
电池未连接		每秒鸣响一次
过度充电		每秒鸣响一次
过温		每秒鸣响一次
充电器故障		每秒鸣响一次
电池故障		每秒鸣响一次
超出旁路电压范围		每秒鸣响一次
旁路频率不稳定		每秒鸣响一次
EEPROM 错误		每秒鸣响一次
EPO 启用		每秒鸣响一次

4. 故障排除

如果 UPS 系统无法正常运行, 请使用下表解决问题。

症状	潜在原因	解决办法
即使电源正常, 也没有指示和警报。	交流输入电源未连接好	检查输入电源线是否牢固地连接到电源。
	交流输入连接到 UPS 输出	检查输入电源线是否牢固地连接到电源。
图标 和警告 在 LCD 显示屏上闪烁。警报每秒鸣响一次。	EPO 功能已激活	将电路设置为闭合状态位置以禁用 EPO 功能

图标  和闪烁  出现 LCD 显示屏上，警报每秒鸣响一次。	外部或内部电池连接不正确	检查所有电池是否连接良好
故障代码显示为 27，LCD 显示屏上的图标  亮起 警报持续响起。	电池电压过高或充电器出现故障。	请联系您的经销商。
故障代码显示为 28，LCD 显示屏上的图标  亮起 警报持续响起。	电池电压过低或充电器出现故障。	请联系您的经销商。
图标  和  在 LCD 显示屏上闪烁，警报每秒鸣响两次。	UPS 过载	从 UPS 输出中移除多余的负载。
	UPS 过载。连接到 UPS 的设备由电网通过 Bypass 直接供电。	
	在反复过载后，UPS 被锁定在 Bypass 模式。连接的设备由电源直接供电	首先从 UPS 输出中移除多余的负载。然后关闭 UPS 并重新启动它
故障代码显示为 43，LCD 显示屏上的图标  亮起 警报持续响起。	由于 UPS 输出过载，UPS 会自动关闭。	从 UPS 输出中移除多余的负载并重新启动它。
故障代码显示为 14，LCD 显示屏上的图标  亮起，警报持续响起	UPS 自动关闭，因为 UPS 输出发生短路	检查输出接线以及连接的设备是否处于短路状态
故障代码在 LCD 显示屏上显示为 01、02、03、04、11、12、13、41 和 45，并且警报持续响起。	发生 UPS 内部故障。有两种可能的结果： 1. 负载仍然供电，但通过旁路直接来自交流电源。 2. 负载不再由电源供电。	联系您的经销商
备用电池时间短于标称	电池未充满	为电池充电至少 5 小时，然后检查容量。如果问题仍然存在，请咨询您的经销商。 请联系您的经销商更换电池
	电池缺陷	

5. 存储与维护

操作

UPS 系统不包含用户可维修的部件。如果超过电池使用寿命（环境温度 25°C 下 3~5 年），则必须更换电池。在这种情况下，请联系您的经销商。



请务必将废电池运送到回收设施，或将其与更换电池包装材料一起运送给您的经销商。

存储

存放前，为 UPS 充电 5 小时。将 UPS 盖好并直立存放在阴凉、干燥的位置。在存放过程中，按照下表为电池充电：

存储温度	充电频率	充电持续时间
-25°C - 40°C	每 3 个月	1-2 小时
40°C - 45°C	每 2 个月	1-2 小时